

# SLIDE

Slide speed gate with folding&sliding high leaves guarantees effective protection and is a stylish original solution for your site. This is a truly unique access point for the most advanced sites, where security should not compromise with appearance and style.

Movement principle allows to keep narrow cabinet even for wide lane, and ensure safety for users. In the same time security features of the gate maintain proper protection of the site. Customization options allow the turnstile to blend-in seamlessly with the existing environment of lobbies of office centers, banks and other institutions.



## UNIQUE AND ELEGANT ACCESS SOLUTION

FOR STYLISH LOBBIES OF OFFICE CENTERS AND BANKS



### Key features:

- BMDrive® - a reliable mechanism with a powerful BLDC gear motor ensures long term maintenance-free operation.
- Speed gate is equipped with a smart self-diagnosing system.
- The innovative controller with an OLED display and buttons for easy setup and configuration without special programmers.
- Digital control of force and leaf speed in combination with safety sensors prevent a person from being struck by a leaf, even in case of an unauthorized passage.
- The sensor system allows detecting the passage of a person with luggage, or arranging a free exit without the need for identification.
- Elegant cabinets are equipped with integrated LED lighting showing access status and card reader area.
- The same dimensions of cabinet for normal (550 mm) and wide lane (900 mm).
- The ability to customize housing design and top lid.
- Low power consumption.
- Can be integrated with any type of access control systems.
- Wired remote control panel in standard kit.
- In case of power failure, leaves could be opened manually (fail-safe).



[www.tiso.global](http://www.tiso.global)  
+380 (44) 291-21-11  
[sales@tiso.global](mailto:sales@tiso.global)



# TECHNICAL SPECIFICATIONS /

Model	Slide 550	Slide 900
Cabinet width, mm	154	
Cabinet length, mm	1435	
Cabinet height, mm	1050	
Leaves height, mm	850 / 1200 / 1500 / 1800	
Passage width, mm	550	900
Opening/closing time, sec	0,7	1,0
Mechanism	BMDrive® servodrive (BLDC)	
Blocking system	FoldEmLock®	
Emergency mode (fire-alarm)	Free entry/exit (leaves are opened automatically)	
Power fail	Fail safe (gates could be opened manually — standard)	
MCBF, cycles	10 000 000	

## Electrical Specifications:

Maximum power consumption, W	160
Voltage	From the AC (100-240)V, 50/60Hz; from a DC source 12 V
Indication	DotLights®, RFIDLights®, EdgeLights®, FloorLights®

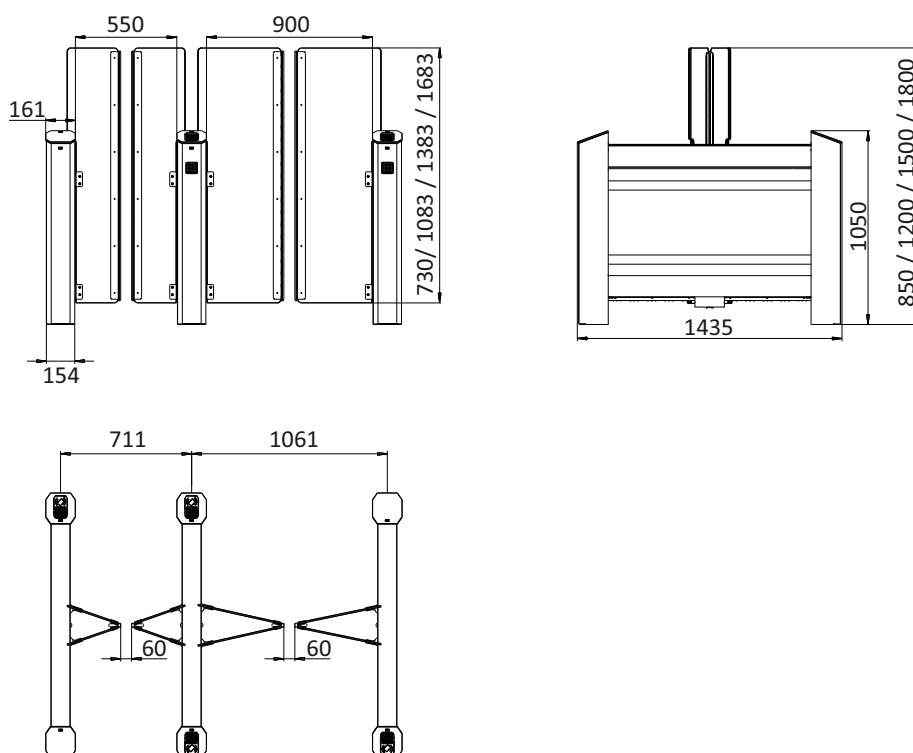

## Finishing

Standard housing	Brushed SS AISI 304
Available housing	Brushed SS AISI 316; Polished SS AISI 304; Polished SS AISI 316; Powder coated RAL



Specifications are subject to change without prior notice



 [www.tiso.global](http://www.tiso.global)  
 +380 (44) 291-21-11  
 [sales@tiso.global](mailto:sales@tiso.global)



# STANDARD FEATURES

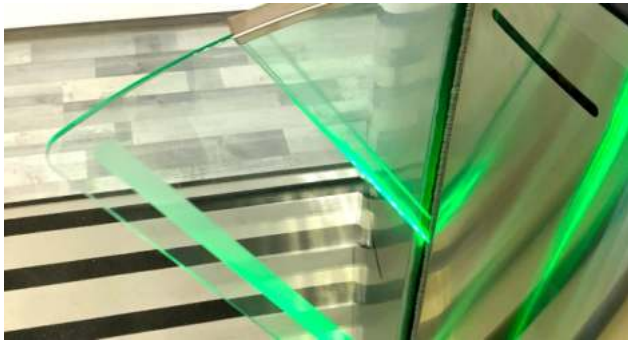

## LEAFLIGHT®

Impressive illumination of the leaves can be in three colors (standard), marking the status of passage: blue - standby mode; green - access authorized; red - access denied.



## CONTROL PANEL

The wired control panel goes in a standard set. Allows to implement a single passage, a free passage, as well as blocks an access and activates the anti-panic function.



## SAFETY SENSORS, ANTI-TAILGATING FUNCTION

High-precision sensors that identify the unauthorized passage of two or more people (antitailgating function). At the same time safety sensors guarantee safe passage for people with luggage or trolleys - the gates won't close until the person finishes the passage.



## UPS FUNCTION

A complex UPS system that automatically switches power to work from the back-up battery. This allows you to use all the functions of the speed gate in case of power fail.



## LED INDICATIONS

Bright and attention-grabbing RFIDLIGHT® (LED light of card reader area) and DotLight® (LED lighting display showing access status).



## PLACE FOR RFID INSTALLATION

Place for RFID installation is provided in the standard configuration of the speedgate.

# ADDITIONAL OPTIONS /

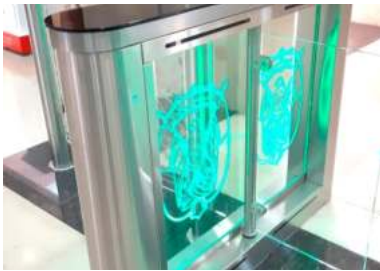

## PATTERN APPLICATION

Unique signatures, customized patterns, logos and others can be placed on the leaves, housing or top lid of speed gates.



## MP3 AUDIO MODULE

Audio signals for unauthorised access / authorised access / closing / opening / alarm.



## KEYFOBS FOR RADIO REMOTE CONTROLLER

Minimalistic keyfobs for opening and blocking the passage.



## INTEGRATION OF CUSTOMIZED ACS

Any access control systems upon request (e.g. RFID device, coin acceptor push button, fingerprint, face recognition, barcode and QRcode reader).



## TWIC WIRELESS CONTROL PANEL

TiSO TWIC were developed for the remote control of multiple lines of turnstiles. The space saving 10" touch screen display can be located at a reception desk or within security control areas.



## SUPER CAPASITOR

Maintenance of a free power package for emergency automatical one time opening of the speed gate.



## FOOTPRINT ILLUMINATION

LED illumination of the footprint of the speed gate housing. The color of the light may vary depending on your request.

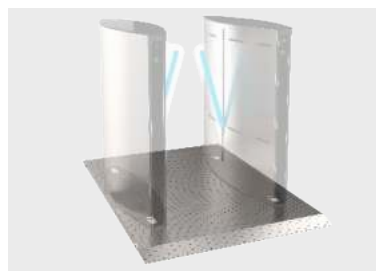

## MOBILE PLATFORM

Ensures quick temporary speed gate installation. As well as can be installed in areas where it is impossible to drill the floor.



## EXIT BUTTON

A convenient option that allows you to organize an exit by using a touch free button.

# ADDITIONAL OPTIONS /

RANDOMIZER  
RANDOMIZER  
RANDOMIZER

## RANDOMIZER

This mechanism automatically randomly selects a person for verification, without the influence of the human factor.



## CARD COLLECTOR INTEGRATION

Possible to integrate the automatic card collector into the speed gate housing.



## RFID READERS T-PROX MINI

Reader operates with 125 kHz cards, Mifare, Mifare Plus and mobile credentials U-Prox ID over NFC and over 2.4 GHz radio.



## JUMPING OVER TOP LEAD ALARM

Weight sensors detect over 10 kg impact on the top lid and activate alarm.



## COUNTER OF PASSAGES

Automatic counting of the number of passes.

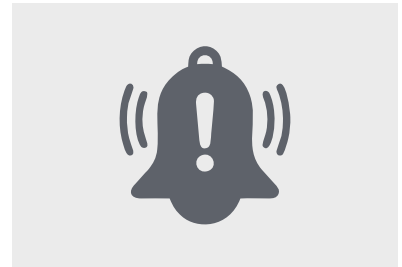

## ALARM BUZZER

Sound alarm during unauthorised access.